

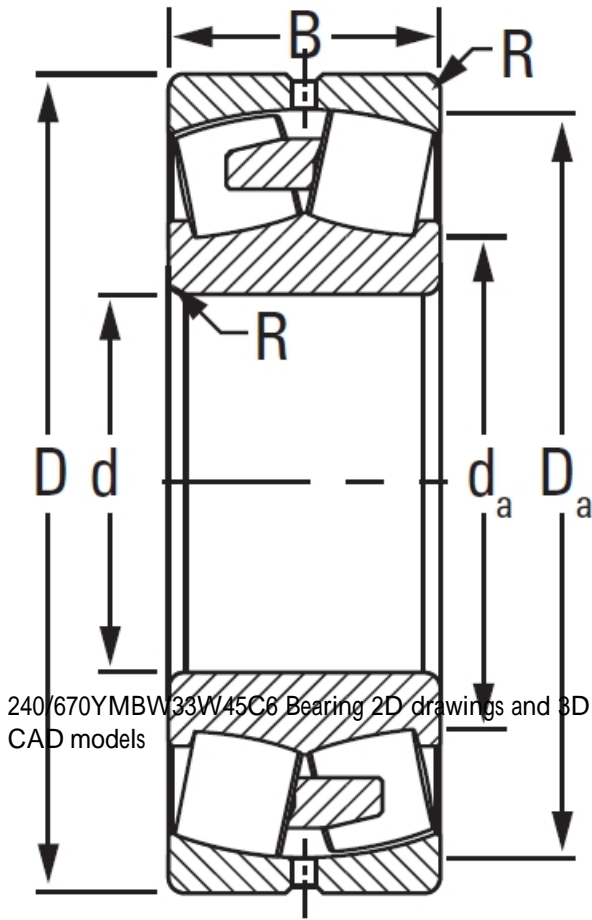

JOP BEARING MFG. CORP.

240/670YMBW33W45C6 TIMKEN Tapered Roller Bearings Tapered Single Imperial

Bearing No. 240/670YMBW33W45C6



240/670YMBW33W45C6 Bearing 2D drawings and 3D CAD models

Design Unit	METRIC
Bearing Weight	794.500 Kg
Cage Type	YMB
UPC Code	087796236493
Cage Material	Brass
d	670.000 mm
D	980.000 mm
B - Inner Ring Width	308 mm
B - Outer Ring Width	308.000 mm
R - Inner Ring To Clear Radius ¹	6.000 mm
r - Outer Ring To Clear Radius ²	6.000 mm
da - Inner Ring Backing Diameter	738.000 mm
Da - Outer Ring Backing Diameter	910.000 mm
C0 - Static Radial Rating	21800000 N
C1(2) - Dynamic Radial Rating (Two-Rows)	10200000 N
e - ISO Factor ³	0.28
Y0 - ISO Factor ⁴	2.39
Y1 - ISO Factor ⁵	3.55
Y2 - ISO Factor ⁶	2.33
Reference Thermal Speed Rating (Grease)	230
Reference Thermal Speed Rating (Oil) ⁷	240



JOP BEARING MFG.CORP.

Cg - Geometry Factor ⁸	0.1256
-----------------------------------	--------